

ASTM CATEGORY 1 : road only
 Recommended weight limit : 120kg
 Recommended tire sizes: 23 to 32 mm
 Max. Pressure: 23mm 8.7 bars - 125 psi, 25/28mm 7.7 bars - 110 psi
 Max. Pressure: 25mm 7.7 bars - 110 PSI

REFERENCES WHEELS

F69551 Cosmic Ultimate17Ft

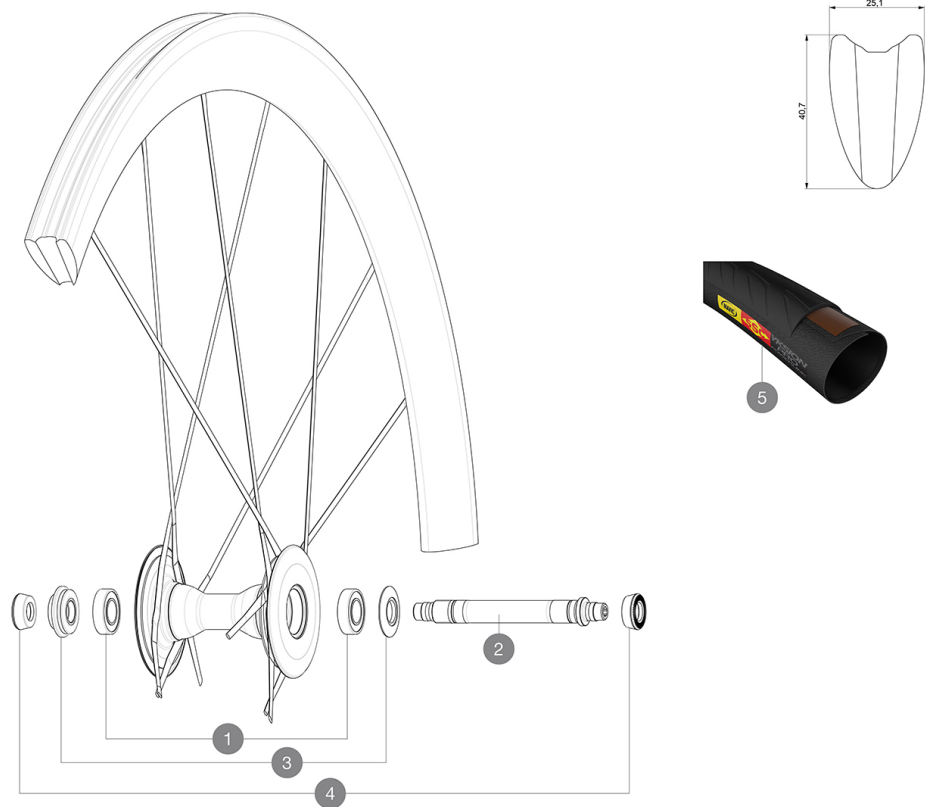

HUB SHELLS





1	LM4007800	FRONT HUB BEARINGS 6901 x 2
2	L36645800	FRONT AXLE COSMIC CARBON ULTIMATE from 2014
3	L36645900	FRT ADJUST NUT/CAP CARBON ULTIMATE from 2014
4	L35117300	FT/RR FORK REST R-SYS/CC ULTIMATE > 2013/KSY PRO CARB T

TYRES

5	L37804400	Yksion Pro GripTub SSC
---	-----------	------------------------

MAVIC Cosmic Ultimate

DELIVERED WITH

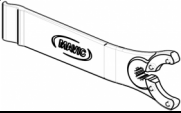
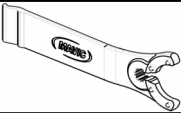
BR601 Titanium quick releases (323 485 01 frt, 323 486 01 rear) 1	
BR601 Titanium quick releases (323 485 01 frt, 323 486 01 rear) 1	
Carbon brake pads (V24 603 01 Shimano/Sram, V24 604 01 Campagnolo) 1 pair	
Carbon brake pads (V24 603 01 Shimano/Sram, V24 604 01 Campagnolo) 1 pair	
Multifunction adjustment wrench (325 423 01) 1	
Multifunction adjustment wrench (325 423 01) 1	
User guide	
User guide	

COMPATIBILITY

Freewheel: Shimano/Sram, convertible to Campagnolo with optional driver body	
Freewheel: Shimano/Sram, convertible to Campagnolo with optional driver body	
Front axle: Quick Release only	
Front axle: Quick Release only	
Rear axle: Quick Release only	
Rear axle: Quick Release only	

Specifications

RIMS

- **Material** : 3K carbon fibers
- **Material** : 3K carbon fibers
- **Height** : 40 mm
- **Height** : 40 mm
- **Drilling** : no holes, spokes molded to the rim
- **Drilling** : no holes, spokes molded to the rim
- **Brake track** : carbon with TgMAX technology
- **Brake track** : carbon with TgMAX technology
- **Valve hole diameter** : 6.5 mm
- **Valve hole diameter** : 6.5 mm
- **Tire** : tubular
- **Tire** : tubular
- **ETRTO size** : 28" tubular
- **ETRTO size** : 28" tubular

SPOKES

- **Material** : unidirectional carbon fiber
- **Material** : unidirectional carbon fiber
- **Shape** : R2R
- **Shape** : R2R
- **Nipples** : steel, ABS
- **Nipples** : steel, ABS
- **Count** : 20 front and rear
- **Count** : 20 front and rear
- **Lacing** : crossed 2 front and rear drive side, radial non drive side
- **Lacing** : crossed 2 front and rear drive side, radial non drive side

WHEEL HUB

- **Front body** : Front 100% carbon
- **Front body** : Front 100% carbon
- **Rear body** : aluminum
- **Rear body** : aluminum
- **Axle material** : aluminum
- **Axle material** : aluminum
- Adjustable sealed cartridge bearings
- Adjustable sealed cartridge bearings
- **Freewheel** : FTS-L steel
- **Freewheel** : FTS-L steel

VERSIONS

- **Color** : Black only
- **Color** : Black only

WHEEL WEIGHTS

Wheel weight 555