

**MAVIC** *Cosmic Pro Carbon Exalith*

ASTM CATEGORY 1 : road only

Recommended weight limit : 120kg

Recommended tire sizes: 25 to 32 mm

Max. Pressure: 23mm 8.7 bars - 125 psi, 25/28mm 7.7 bars - 110 psi

Max. Pressure: 25mm 7.7 bars - 110 PSI

**REFERENCES WHEELS**

F71851 Cos Pro Car Exa 17 Ft Cus

F54101 Cos Pro Car Exa 17 Ft

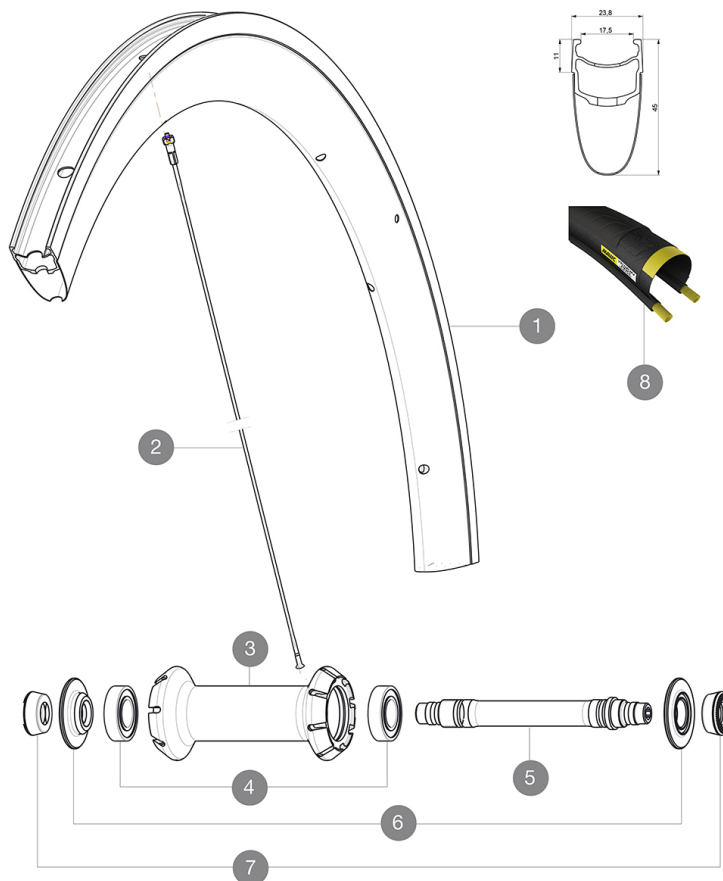
**RIMS**

&amp;NBSP;:

1	LV2407700	KIT FRONT RIM COSMIC PRO CARBON EXALITH GRAPH
---	-----------	---

**SPOKES**

2	LV3663400	KIT 12 FRT BUTTED AERO STAINLESS SPOKE 287 + alu nipple + wa
2	LV2274500	KIT 8 FRT BUTTED AERO SPOKE 287mm/ALU NIPPLE - while stock I

**HUB SHELLS**

3	N/A	HUB BODY
4	LM4007800	FRONT HUB BEARINGS 6901 x 2
5	LV2252500	FRONT SETTING NUT & DUST PROTECTOR MY16
6	L30870000	FRONT AXLE ROAD RIM BRAKING QRM +
7	L35117300	FT/RR FORK REST R-SYS/CC ULTIMATE > 2013/KSY PRO CARB T

**OPTIONS**









LV2470400	BRAKE PADS Exalith Rim Pr Campagnolo
-----------	--------------------------------------

**TYRES**

8	L37805300	YksionProGripLinkWH
---	-----------	---------------------

# MAVIC Cosmic Pro Carbon Exalith

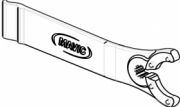
## DELIVERED WITH

BR301 quick releases (V24 501 01 frt, V24 502 01 rear) 1	
BR301 quick releases (V24 501 01 frt, V24 502 01 rear) 1	
BR301 quick releases (V24 501 01 frt, V24 502 01 rear) 1	
Exalith brake pads (V24 703 01 Shimano/Sram, V24 704 01 Campagnolo) 1	
Exalith brake pads (V24 703 01 Shimano/Sram, V24 704 01 Campagnolo) 1	
Exalith brake pads (V24 703 01 Shimano/Sram, V24 704 01 Campagnolo) 1	
Rim tape	
Rim tape	
Rim tape	
Multifunction adjustment wrench (325 423 01) 1	
Multifunction adjustment wrench (325 423 01) 1	
Multifunction adjustment wrench (325 423 01) 1	
User guide	
User guide	
User guide	

## COMPATIBILITY

Freewheel: Shimano/Sram or Campagnolo, convertible to XD-R with optional driver body	
Freewheel: Shimano/Sram, convertible to Campagnolo and XD-R with optional driver bodies	
Freewheel: Shimano/Sram, convertible to Campagnolo and XD-R with optional driver bodies	
Front axle: Quick Release only	
Front axle: Quick Release only	
Front axle: Quick Release only	
Rear axle: Quick Release only	
Rear axle: Quick Release only	
Rear axle: Quick Release only	

## Specifications

### RIMS

- **Material** : Mxxtal and 12K carbon fiber
- **Material** : Mxxtal and 12K carbon fiber
- **Material** : Mxxtal and 12K carbon fiber
- **Height** : 52 mm
- **Height** : 52 mm
- **Height** : 52 mm
- **Joint** : SUP
- **Joint** : SUP
- **Joint** : SUP
- **Drilling** : traditional

### WHEEL HUB

- **Front and rear bodies** : aluminum
- **Front and rear bodies** : aluminum
- **Front and rear bodies** : aluminum
- **Axle material** : aluminum
- **Axle material** : aluminum
- **Axle material** : aluminum
- **Front bearings** : adjustable sealed cartridge bearings (QRM+), Rear bearings auto adjust sealed cartridge bearings (QRM Auto)
- **Front bearings** : adjustable sealed cartridge

### WHEEL WEIGHTS

Wheel weight 755