

MAVIC Cosmic Pro Carbon

ASTM CATEGORY 1 : road only

Recommended weight limit : 120kg

Recommended tire sizes: 25 to 32 mm

Max. Pressure: 23mm 8.7 bars - 125 psi, 25/28mm 7.7 bars - 110 psi

Max. Pressure: 25mm 7.7 bars - 110 PSI

REFERENCES WHEELS

F71861	Cos Pro Car 17 Ft Custom	F54202	Cos Pro Car 17 Ft White
F54201	Cos Pro Car 17 Ft Black		

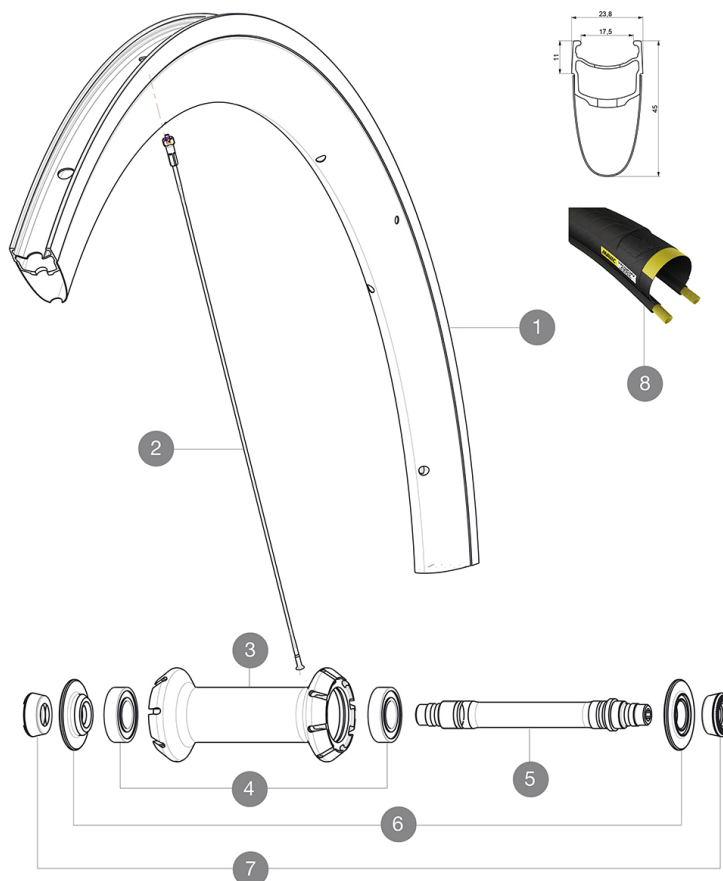

RIMS



&NBSP;:

1	LV4091800	KIT FRONT RIM COSMIC PRO CARBON U shaped
1	LV2407500	KIT FRONT RIM COSMIC PRO CARBON UB WHITE - while stock last
1	LV2407300	KIT FRONT RIM COSMIC PRO CARBON UB GRAPHITE - while stock la

SPOKES

2	LV3663400	KIT 12 FRT BUTTED AERO STAINLESS SPOKE 287 + alu nipple + wa
2	LV2274500	KIT 8 FRT BUTTED AERO SPOKE 287mm/ALU NIPPLE - while stock l

HUB SHELLS



3	N/A	HUB BODY
4	M40078	FRONT HUB BEARINGS 6901 x 2
5	L30870000	FRONT AXLE ROAD RIM BRAKING QRM +
6	V2252501	FRONT SETTING NUT & DUST PROTECTOR MY16
7	35117301	FT/RR FORK REST R-SYS/CC ULTIMATE > 2013/KSY PRO CARB T

TYRES

8	L37805300	YksionProGripLinkWH
---	-----------	---------------------

MAVIC Cosmic Pro Carbon

DELIVERED WITH

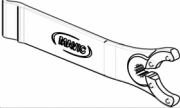
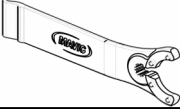
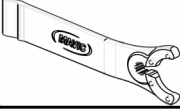
BR301 quick releases (V24 501 01 frt, V24 502 01 rear) 1	
BR301 quick releases (V24 501 01 frt, V24 502 01 rear) 1	
BR301 quick releases (V24 501 01 frt, V24 502 01 rear) 1	
Rim tape	
Rim tape	
Rim tape	
Multifunction adjustment wrench (325 423 01) 1	
Multifunction adjustment wrench (325 423 01) 1	
Multifunction adjustment wrench (325 423 01) 1	
User guide	
User guide	
User guide	

COMPATIBILITY

Freewheel: Shimano/Sram, convertible to Campagnolo and XD-R with optional driver bodies	
Freewheel: Shimano/Sram, convertible to Campagnolo and XD-R with optional driver bodies	
Freewheel: Shimano/Sram, convertible to Campagnolo and XD-R with optional driver bodies	
Front axle: Quick Release only	
Front axle: Quick Release only	
Front axle: Quick Release only	
Rear axle: Quick Release only	
Rear axle: Quick Release only	
Rear axle: Quick Release only	

Specifications

RIMS

- **Material** : Maxtal and 12K carbon fiber
- **Material** : Maxtal and 12K carbon fiber
- **Material** : Maxtal and 12K carbon fiber
- **Height** : 52 mm
- **Height** : 52 mm
- **Height** : 52 mm
- **Joint** : SUP
- **Joint** : SUP
- **Joint** : SUP
- **Drilling** : traditional
- **Drilling** : traditional
- **Drilling** : traditional
- **Brake track** : UB Control
- **Brake track** : UB Control
- **Brake track** : UB Control
- **Weight reduction** : ISM
- **Weight reduction** : ISM
- **Weight reduction** : ISM
- **Valve hole diameter** : 6.5 mm
- **Valve hole diameter** : 6.5 mm
- **Valve hole diameter** : 6.5 mm
- **Tire** : clincher

WHEEL HUB

- **Front and rear bodies** : aluminum
- **Front and rear bodies** : aluminum
- **Front and rear bodies** : aluminum
- **Axle material** : aluminum
- **Axle material** : aluminum
- **Axle material** : aluminum
- **Front bearings** : adjustable sealed cartridge bearings (QRM+), Rear bearings auto adjust sealed cartridge bearings (QRM Auto)
- **Front bearings** : adjustable sealed cartridge bearings (QRM+), Rear bearings auto adjust sealed cartridge bearings (QRM Auto)
- **Front bearings** : adjustable sealed cartridge bearings (QRM+), Rear bearings auto adjust sealed cartridge bearings (QRM Auto)
- **Sealed cartridge bearings**
- **Freewheel** : Instant Drive 360
- **Freewheel** : Instant Drive 360
- **Freewheel** : Instant Drive 360

VERSIONS

- **Color** : Black only
- **Color** : Black only

WHEEL WEIGHTS

Wheel weight 755