

MAVIC Cosmic Pro Carbon

1
2017
FRONT

ASTM CATEGORY 1 : road only
Recommended weight limit : 120kg
Recommended tire sizes: 25 to 32 mm
Max. Pressure: 23mm 8.7 bars - 125 psi, 25/28mm 7.7 bars - 110 psi
Max. Pressure: 25mm 7.7 bars - 110 PSI

REFERENCES WHEELS

F71861	Cos Pro Car 17 Ft Custom	F54202	Cos Pro Car 17 Ft White
F54201	Cos Pro Car 17 Ft Black		

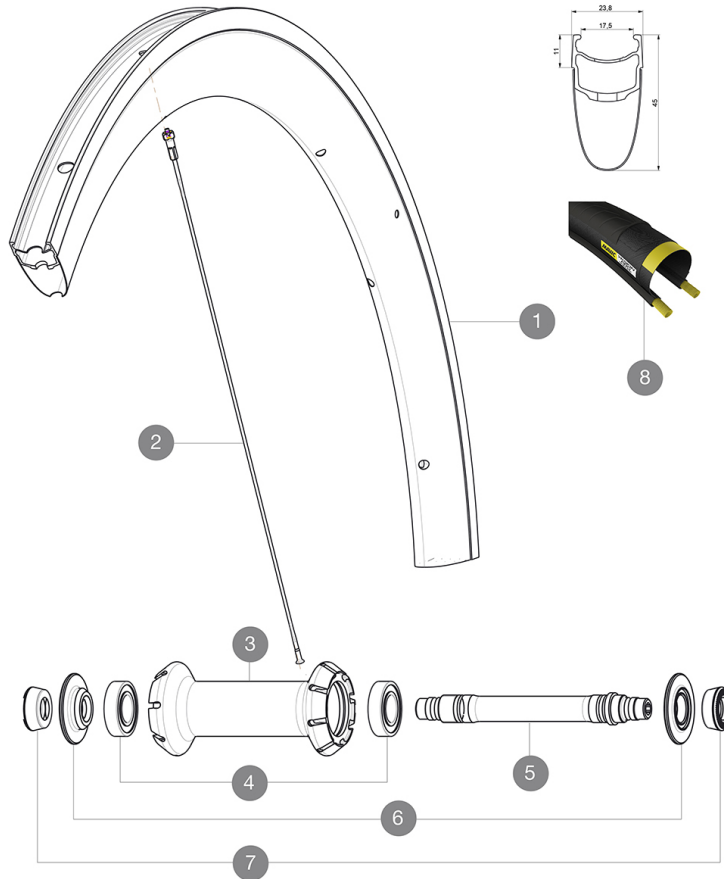

RIMS



&NBSP;:

1	LV4091800	KIT FRONT RIM COSMIC PRO CARBON U shaped
1	LV2407500	KIT FRONT RIM COSMIC PRO CARBON UB WHITE - while stock last
1	LV2407300	KIT FRONT RIM COSMIC PRO CARBON UB GRAPHITE - while stock la

SPOKES

2	LV3663400	KIT 12 FRT BUTTED AERO STAINLESS SPOKE 287 + alu nipple + wa
2	LV2274500	KIT 8 FRT BUTTED AERO SPOKE 287mm/ALU NIPPLE - while stock l

HUB SHELLS



3	N/A	HUB BODY
4	M40078	FRONT HUB BEARINGS 6901 x 2
5	L30870000	FRONT AXLE ROAD RIM BRAKING QRM +
6	V2252501	FRONT SETTING NUT & DUST PROTECTOR MY16
7	35117301	FT/RR FORK REST R-SYS/CC ULTIMATE > 2013/KSY PRO CARB T

TYRES

8	L37805300	YksionProGripLinkWH
---	-----------	---------------------

MAVIC Cosmic Pro Carbon

DELIVERED WITH

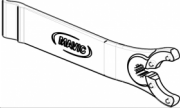
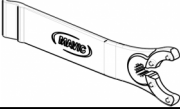
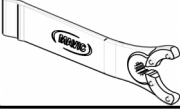
BR301 quick releases (V24 501 01 frt, V24 502 01 rear) 1	
BR301 quick releases (V24 501 01 frt, V24 502 01 rear) 1	
BR301 quick releases (V24 501 01 frt, V24 502 01 rear) 1	
Rim tape	
Rim tape	
Rim tape	
Multifunction adjustment wrench (325 423 01) 1	
Multifunction adjustment wrench (325 423 01) 1	
Multifunction adjustment wrench (325 423 01) 1	
User guide	
User guide	
User guide	

COMPATIBILITY

Freewheel: Shimano/Sram, convertible to Campagnolo and XD-R with optional driver bodies	
Freewheel: Shimano/Sram, convertible to Campagnolo and XD-R with optional driver bodies	
Freewheel: Shimano/Sram, convertible to Campagnolo and XD-R with optional driver bodies	
Front axle: Quick Release only	
Front axle: Quick Release only	
Front axle: Quick Release only	
Rear axle: Quick Release only	
Rear axle: Quick Release only	
Rear axle: Quick Release only	

Specifications

RIMS

- Material : Maxtal and 12K carbon fiber
- Material : Maxtal and 12K carbon fiber
- Material : Maxtal and 12K carbon fiber
- Height : 52 mm
- Height : 52 mm
- Height : 52 mm
- Joint : SUP
- Joint : SUP
- Joint : SUP
- Drilling : traditional
- Drilling : traditional
- Drilling : traditional
- Brake track : UB Control
- Brake track : UB Control
- Brake track : UB Control
- Weight reduction : ISM
- Weight reduction : ISM
- Weight reduction : ISM
- Valve hole diameter : 6.5 mm
- Valve hole diameter : 6.5 mm
- Valve hole diameter : 6.5 mm
- Tire : clincher

WHEEL HUB

- Front and rear bodies : aluminum
- Front and rear bodies : aluminum
- Front and rear bodies : aluminum
- Axle material : aluminum
- Axle material : aluminum
- Axle material : aluminum
- Front bearings : adjustable sealed cartridge bearings (QRM+), Rear bearings auto adjust sealed cartridge bearings (QRM Auto)
- Front bearings : adjustable sealed cartridge bearings (QRM+), Rear bearings auto adjust sealed cartridge bearings (QRM Auto)
- Front bearings : adjustable sealed cartridge bearings (QRM+), Rear bearings auto adjust sealed cartridge bearings (QRM Auto)
- Sealed cartridge bearings
- Freewheel : Instant Drive 360
- Freewheel : Instant Drive 360
- Freewheel : Instant Drive 360

VERSIONS

- Color : Black only
- Color : Black only

WHEEL WEIGHTS

Wheel weight 755