

ASTM CATEGORY 3 : offroad with jumps less than 61cm
Recommended weight limit : 120kg
Recommended tire sizes: 28 mm to 62 mm (1.1" to 2.5")

REFERENCES WHEELS

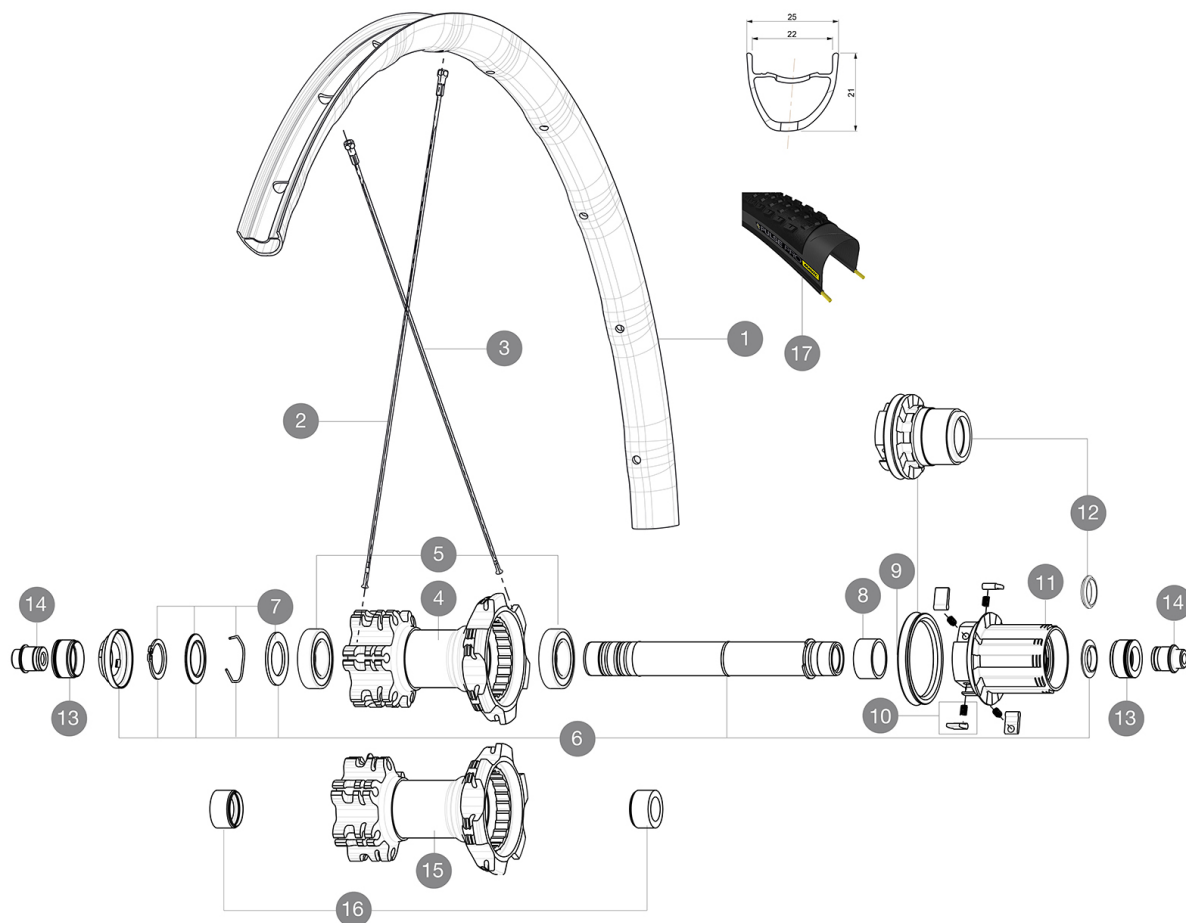

RIMS



Ø VALVE HOLE (MM): 6,5 :

1	LV2950100	KIT FT/RR RIM CROSSMAX EL 29" 22mm BLK TSS
1	LV2970100	KIT FT/RR RIM CROSSMAX EL 29" 22mm RED TSS
	LV2620100	UST RIM TAPE 25mm (for 21-24mm wide rim)

SPOKES

2	LV2382300	KIT 12 DS XRIDE + FTSX/NDS XMAX EL/XA EL 29" SPK 297mm
3	L36689600	"KIT 12 DS CROSSROC/XRIDE UST/XMAX ELITE/XA ELITE 29"" SPK 2

HUB SHELLS







4	N/A	HUB BODY
4	N/A	HUB BODY
5	M40076	HUB BEARINGS 17x30x7 6903 x 2
6	LV2371200	KIT REAR QRM AXLE 135-142mm/BOOST 148mm
7	LV2370400	KIT REAR AUTO ADJUSTING PLAY 12mm AXLE
8	L35124500	SET OF 3 REAR AXLE/FREEWHEEL BODY SPACERS MTB L1
9	L99610700	ITS-4 FREEWHEEL SEAL
10	L99610600	PAWLS KIT FOR ITS-4 (OR TS-2)
11	L35126000	ITS-4 FREEWHEEL BODY + SEAL 2013 (NO PAWLS)
12	L35684100	FREEHUB BODY XD TS2/ITS-4
13	L30872200	FRAME SUPPORT ITS-4 135mm REAR AXLE > 2012
14	L30873100	2 REAR REDUCERS 12/9,5mm 2012 ITS4 HUB
15	N/A	HUB BODY
15	N/A	HUB BODY
16	LV2371400	YELL RR AXLE SUPPORT BOOST 148mm SELF ADJUST

TYRES

17	L39243200	Pulse Pro 29
17	L39243200	Pulse Pro 29

MAVIC Crossmax Elite 29

DELIVERED WITH

1 bottle of Mavic Sealant (355 466 01) 1	
BR101 quick releases (M40350 firt, M40351 rear road, M40352 rear MTB) 1	
Front QR adapters (996 941 01 for MTB or B41 043 01 for road) 1	
Rear 12x142mm adapters for ITS4 and TS2 (308 593 01 for ITS4, 329 650 01 for TS2) 1	
UST valve and accessories (129 838 01)	
UST valve and accessories (129 838 01)	
Tubeless rim tape	
Tubeless rim tape	

COMPATIBILITY

Freewheel: Shimano/Sram or XD	
Freewheel: Shimano/Sram, convertible to XD with optional driver body	
Front axle: convertible from 15mm thru axle to Quick Release with included adapters	
Front axle: convertible from 15mm thru axle to Quick Release with included adapters	
Rear axle: 12mm thru axle, convertible to Quick Release with optional adapters	

Specifications

RIMS

- **Material** : Mxstal
 - **Material** : Mxstal
 - **Joint** : SUP
 - **Joint** : SUP
 - **Drilling** : traditional
 - **Drilling** : traditional
 - **Weight reduction** : ISM 4D
 - **Weight reduction** : ISM 4D
 - **Valve hole diameter** : 6.5 mm
 - **Valve hole diameter** : 6.5 mm
 - **Tire** : UST Tubeless and tubetype
 - **Tire** : UST Tubeless and tubetype
 - **Internal width** : 22 mm
 - **Internal width** : 22 mm
 - **ETRTO size 27.5"** : 584x22ss
 - **ETRTO size 27.5"** : 584x22ss
 - **ETRTO size 29"** : 622x22ss
 - **ETRTO size 29"** : 622x22ss
- Hookless profile
Hookless profile
Use with Mavic Tubeless Tape
Use with Mavic Tubeless Tape

SPOKES

- **Material** : steel
- **Material** : steel
- **Shape** : straight pull, bladed, double butted
- **Shape** : straight pull, bladed, double butted
- **Count** : 24 front and rear
- **Count** : 24 front and rear
- **Lacing** : front and rear crossed 2
- **Lacing** : front and rear crossed 2

WHEEL HUB

- **Front and rear bodies** : aluminum
 - **Front and rear bodies** : aluminum
 - **Axle material** : aluminum
 - **Axle material** : aluminum
- Sealed cartridge bearings
Sealed cartridge bearings
- **Freewheel** : ITS-4 alloy
 - **Freewheel** : ITS-4 alloy

VERSIONS

- **Color** : Black or Black/Red
 - **Color** : Black or Black/Red
 - **Disc standard** : 6 Bolts only
 - **Disc standard** : 6 Bolts only
 - **Hub width** : Boost (front 110, rear 148) or Non-Boost (front 100, rear 135/142)
 - **Hub width** : Boost (front 110, rear 148) or Non-Boost (front 100, rear 135/142)
- Lefty Supermax
Lefty Supermax

WHEEL WEIGHTS

- **Wheel weight**
- **Weight Rear 27.5"**: 885
- **Weight Rear 29"**: 930